

Figuras clase Geostrofia, Teorema de T-P, Viento Térmico y Frentes

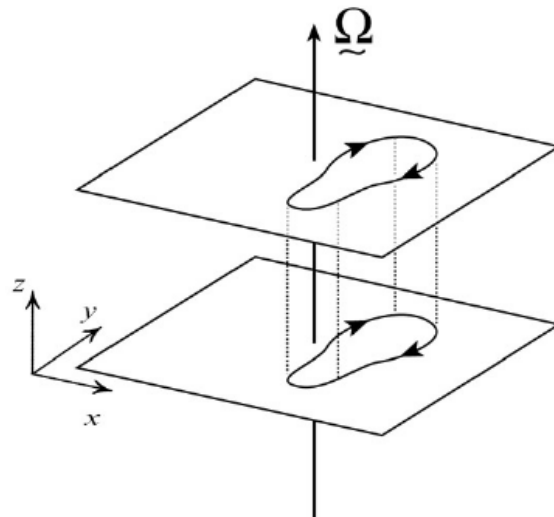

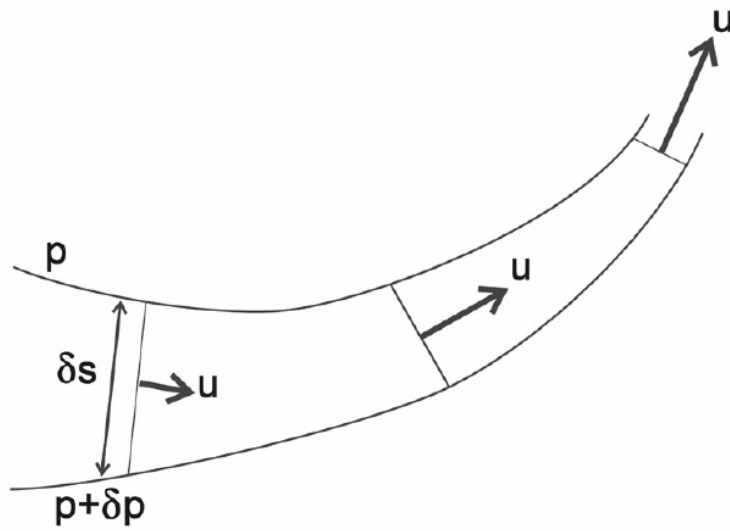

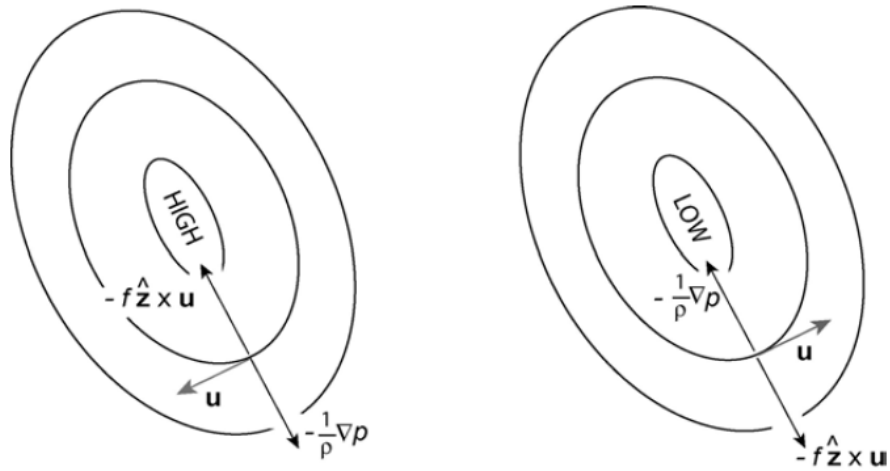
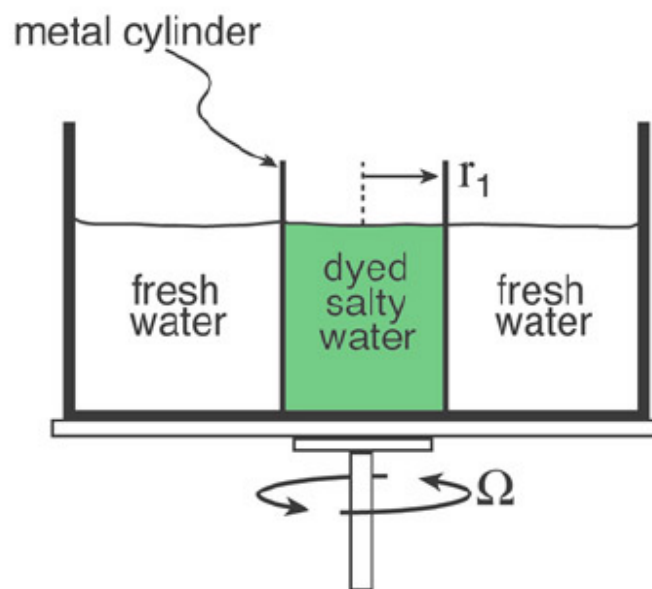
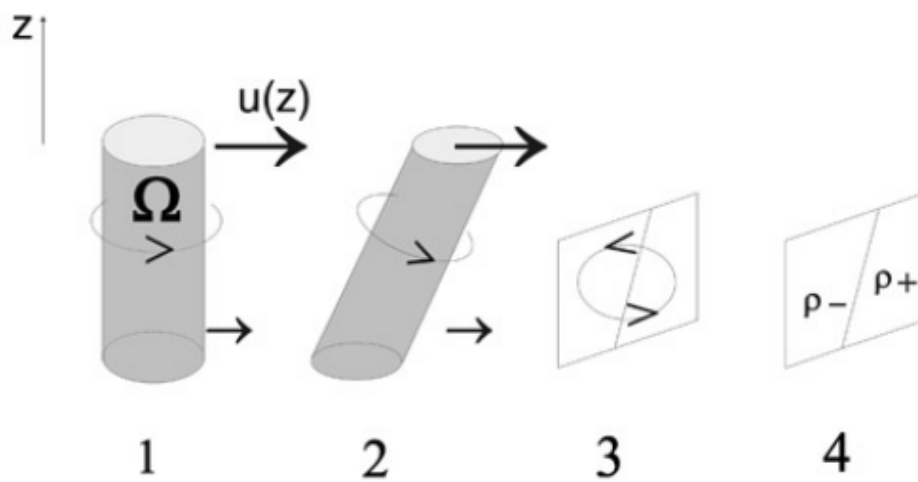
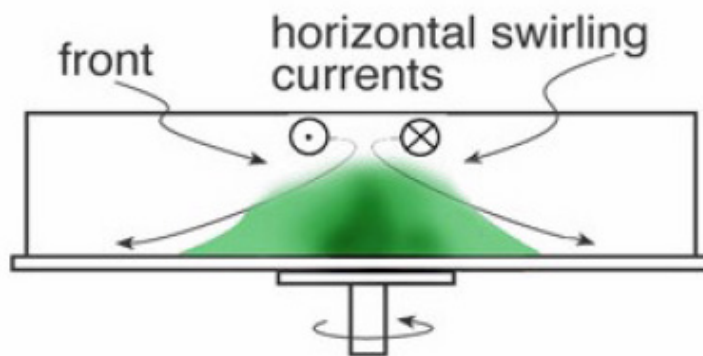
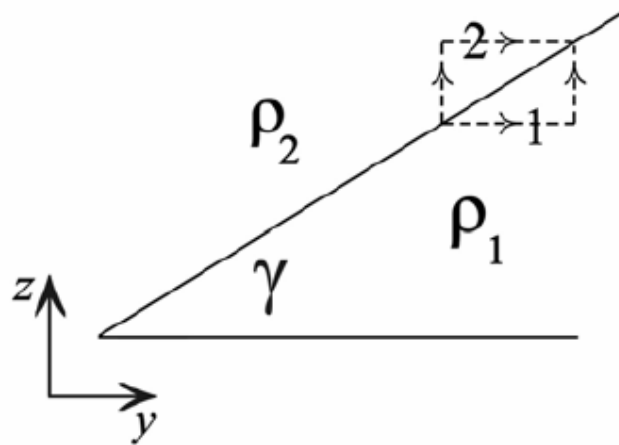
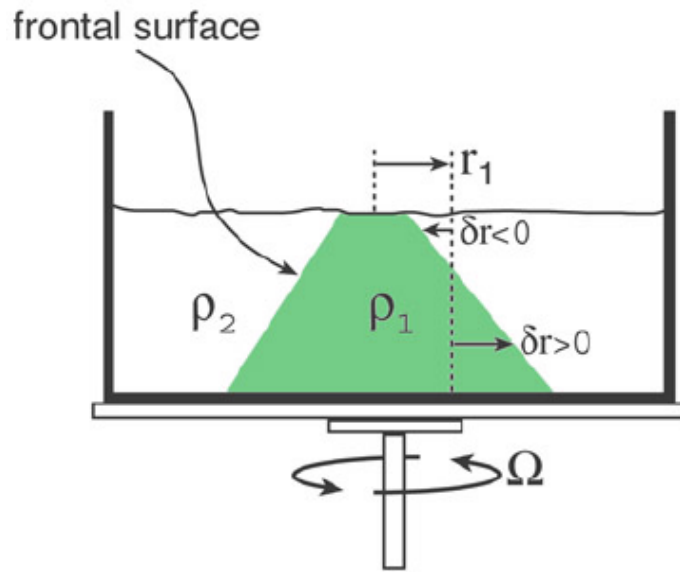

salt water sinking under gravity and rotation

Introducción a la Dinámica del Océano

